

# JOLLY ROGER



Soon to be renamed "Go Pirate"



Visit me on the web at [www.EvilMustacheGames.com](http://www.EvilMustacheGames.com)



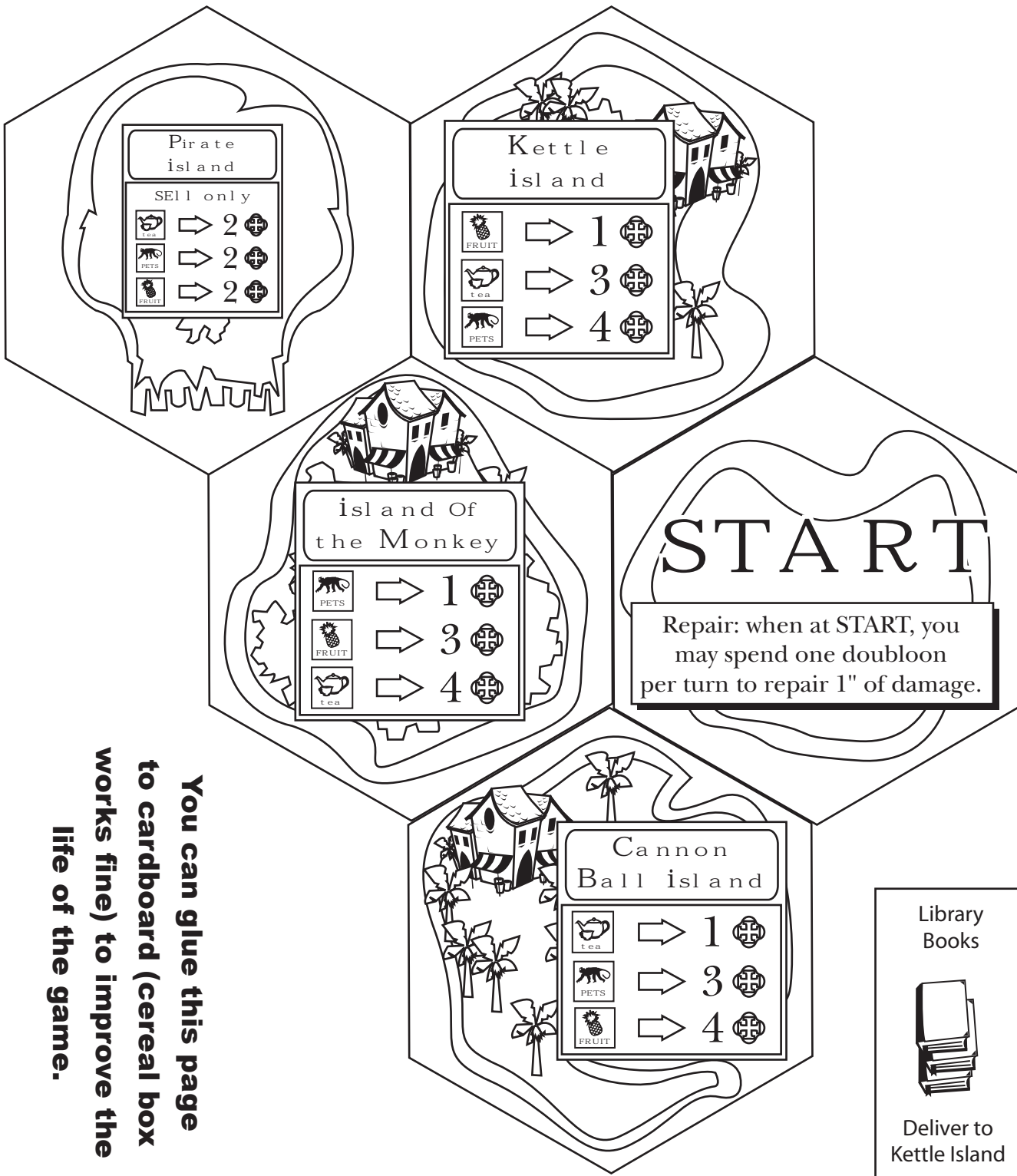



This material is protected under the copyright laws of the United States of America. Any reproduction or unauthorized use of the material or artwork contained herein is prohibited without the express written permission of EvilMustache Games, Inc.





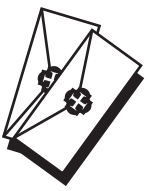











































































© EvilMustache Games, Inc.  
All rights reserved.  
Made in the U.S.A.



**You can glue this page to cardboard (cereal box works fine) to improve the life of the game.**

Library Books 	Birthday Present 
Deliver to Kettle Island	Deliver to Island of the Monkey

Potted Plant 	Medicine 	Legal Documents 	Mail 	Famous Painting of Lady LeRoc 	Monkey Diamond 	Gold Bars 
Deliver to Kettle Island	Deliver to Cannon Ball Island	Deliver to Cannon Ball Island	Deliver to Cannon Ball Island	Deliver to Kettle Island	Deliver to Island of the Monkey	Deliver to Island of the Monkey

 PETS	 FRUIT	 tea					
 PETS	 FRUIT	 tea					
 PETS	 FRUIT	 tea					
 PETS	 FRUIT	 tea					
 PETS	 FRUIT	 tea					
 PETS	 FRUIT	 tea					
 PETS	 FRUIT	 tea					
 PETS	 FRUIT	 tea					
 PETS	 FRUIT	 tea					
 PETS	 FRUIT	 tea					

Name badge: glue to the back of your ship chart

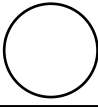
GRADE 

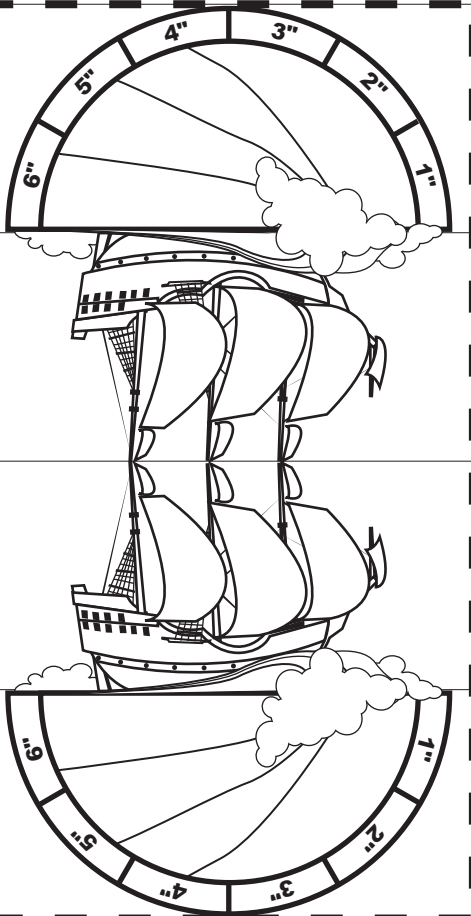
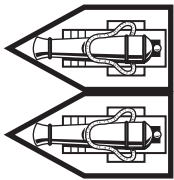



GRADE 

NAME: \_\_\_\_\_

SHIP: \_\_\_\_\_

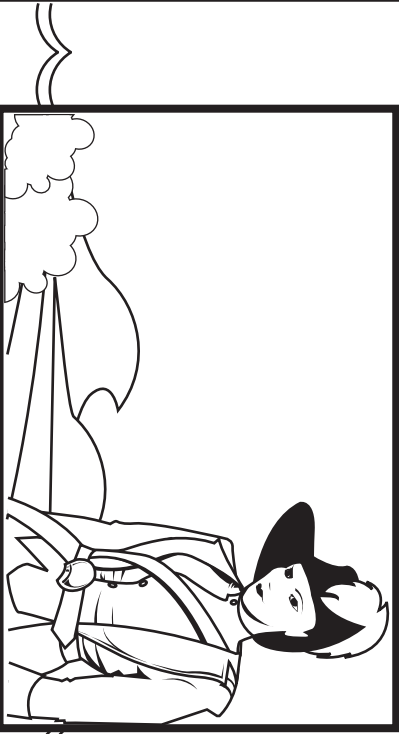
frigate - so many cannons, so little time



CARGO 

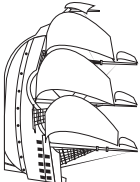

jolly  
roger 

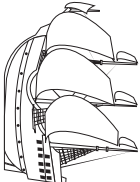
jolly  
roger 

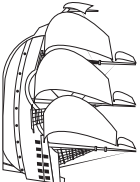
jolly  
roger 

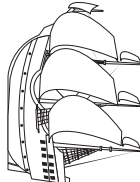
jolly  
roger 

 M. CANNON  
RANGE = 4"  
HIT on 7

 M. CANNON  
RANGE = 4"  
HIT on 7

6"

6"

4"

3"

2"



1" 2" 3" 4" 5" 6"

Name badge: glue to the back of your ship chart

GRADE 

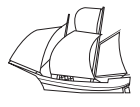
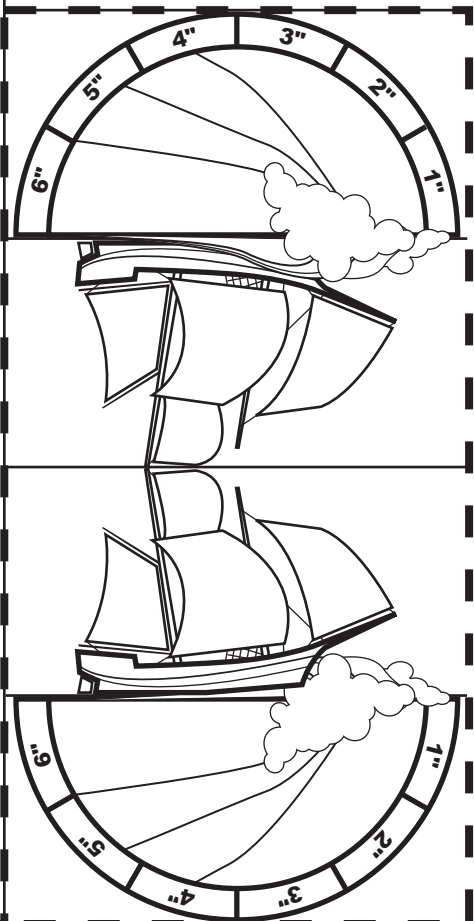
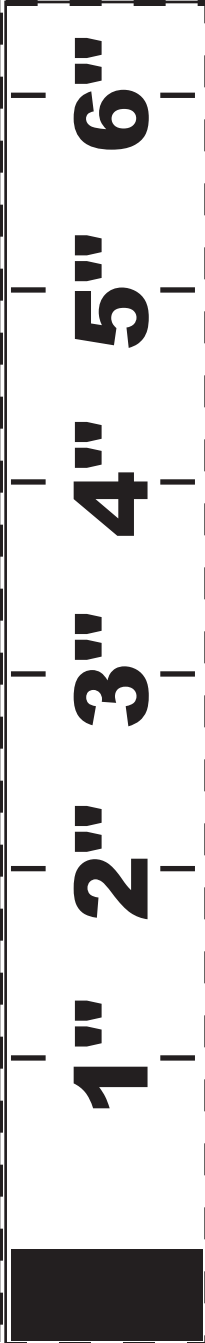
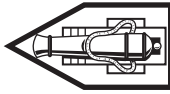
GRADE 

NAME: \_\_\_\_\_

SHIP: \_\_\_\_\_

Galleon - a treasure chest with sails



CARGO  4

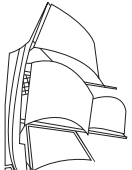

jolly roger 

roger

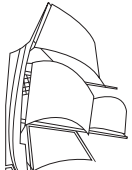
jolly roger 

roger

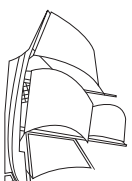
jolly roger 

roger

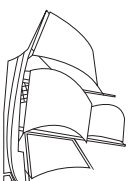
jolly roger 

roger

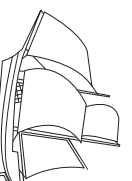
jolly roger 

roger

 M. CANNON  
RANGE = 4"  
HIT on 7

6"

5"

4"

3"

2"

SUNK 

Name badge: glue to the back of your ship chart

GRADE

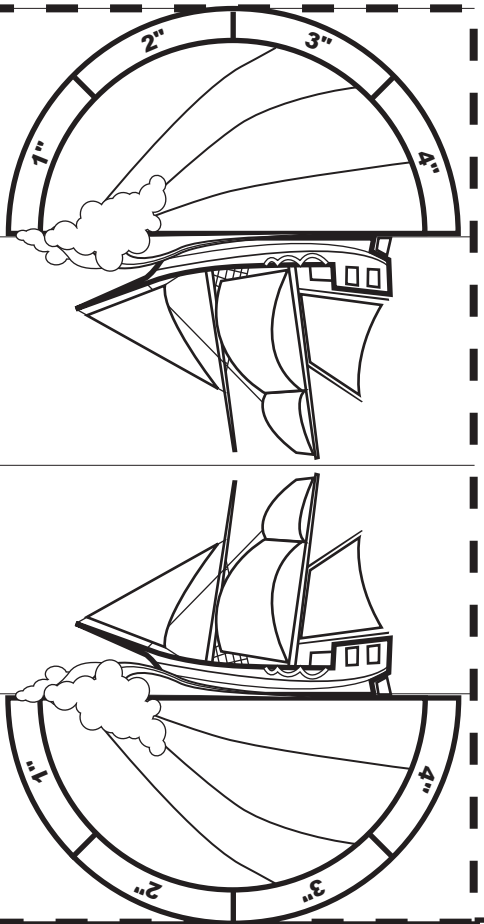
GRADE

NAME:

SHIP:

SCHOONER - can't hit what you can't catch



CARGO

3

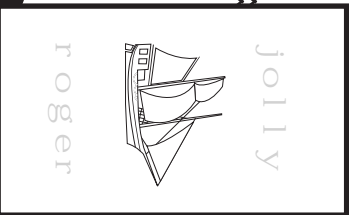
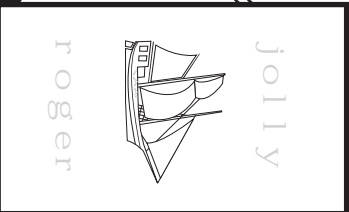
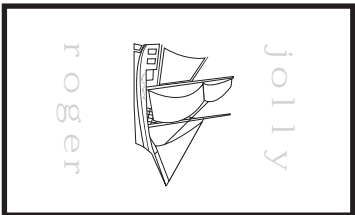
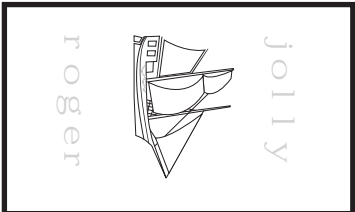

L. CANNON  
RANGE = 5"  
HIT on 8

6"

5"

4"

3"

**SUNK**



1" 2" 3" 4" 5" 6"



# STORE

20

**POWER RUDDER**



+1 TURN

15

**IRON SIDES**



Ignore the first hit you take every game.

15

**PITT The Insider**

You may buy goods at Pirate Island.

15

**MAD EDDY The Pirate**

+1 to HIT when boarding another ship.

15

**HERB The Brewer**



You get 3 free Doubloons for each bunch of TEA you sell (you must sell at least two)

15

**BONKO The CLOWN**



You get 3 free Doubloons for each bunch of PETS you sell (must sell at least two)

15

**SLUSHY The JUICER**



You get 3 free Doubloons for each bunch of FRUIT you sell (must sell at least two)

25

**SELF REPAIR KIT**



At any island, you may spend 2 doubloons to repair 1" of damage per turn.

25

**FREE M. CANNON**



RANGE=4" HIT on 7

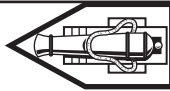

**PITT The Insider**

You may buy goods at Pirate Island.

**MAD EDDY The Pirate**

+1 to HIT when boarding another ship.

**HERB The Brewer**



You get 3 free Doubloons for each bunch of TEA you sell (you must sell at least two)

**BONKO The CLOWN**



You get 3 free Doubloons for each bunch of PETS you sell (must sell at least two)

**SLUSHY The JUICER**



You get 3 free Doubloons for each bunch of FRUIT you sell (must sell at least two)

25





**SUPER SAILS**





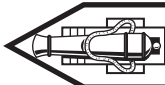
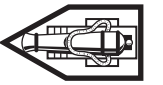
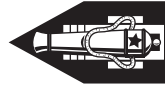

Covers the highest non-6" tab.

**6"**

10

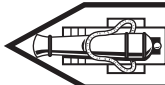
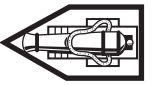
		M. CANNON RANGE = 4" HIT on 7
		S. CANNON RANGE = 3" HIT on 6
		L. CANNON RANGE = 5" HIT on 8

10

		M. CANNON RANGE = 4" HIT on 7
		S. CANNON RANGE = 3" HIT on 6
		L. CANNON RANGE = 5" HIT on 8

20

**CARGO**



**4**

 CARGO = 4

20

**CARGO**



**4**

 CARGO = 4

15

<b>+1</b>	<b>+1</b>	<b>+1</b>
<b>+1</b>	<b>+1</b>	<b>+1</b>

1" 2" 3" 4" 5" 6"

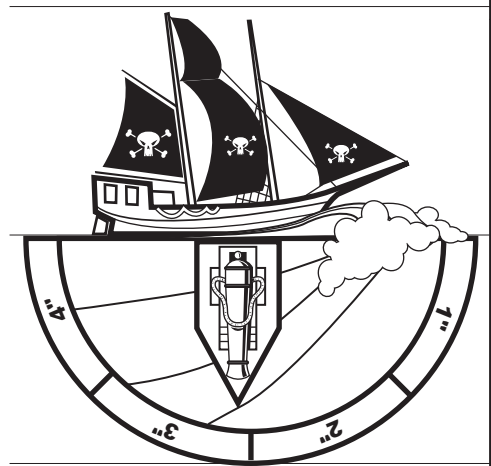
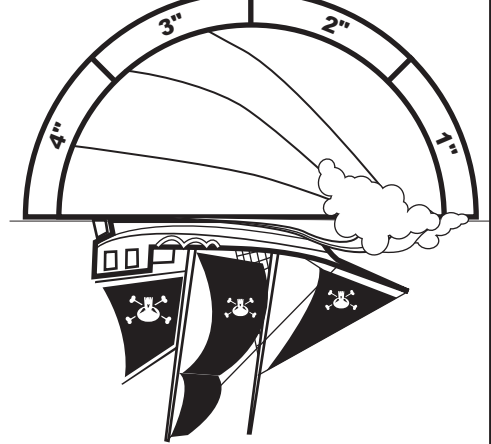

M. CANNON  
RANGE = 4"  
HIT on 7



6"

5"

4"

**SUNK**

M. CANNON  
RANGE = 4"  
HIT on 7



M. CANNON  
RANGE = 4"  
HIT on 7



5"

4"

3"

**SUNK**

